

# **Economic benefits through system integration of electric waste collection vehicles: case study of grid-beneficial charging and discharging strategies**

**Lina Taube (1)<sup>CA</sup>, Florian Biedenbach (1), Fabian Schmid (1), Jenny Rieck (1), Frank Behrendt (1)**

(1) Technische Universität Berlin, Energy Process Engineering and Conversion Technologies for Renewable Energies.  
Seestrasse 13, 13353 Berlin/Germany

Corresponding author (CA):  
Lina Taube  
Tel.: +49-30-314-24381  
[lina.taube@tu-berlin.de](mailto:lina.taube@tu-berlin.de)

Keywords: Load management, e-mobility, peak load, balancing power, electricity market

## **Abstract**

Electrification of a waste collection fleet as part of vehicle-to-grid can be used in a grid-beneficial way, which in turn can increase the economy of these vehicles. In this study the system and grid integration of fully battery-electric waste collection vehicles (eWCV) is examined. The possibility to shave power peaks of a lightweight packaging plant and to provide balancing power by eWCV are analyzed. For this, performance and market models are developed using an ex-post analysis, considering also levies and charges. Building on this, various scenarios for the grid-beneficial integration of eWCV are designed. These are assessed based on the resulting energy consumption of the eWCV, charging costs and feasibility for real-life implementation. It is shown that using electricity generated by thermal waste management plants for charging can reduce the operation costs of eWCV. Also, peak shaving is viable from an economic point of view. Network charges and well as the complexity of the system prevent an economical provision of balancing power by eWCV.

## **1. Introduction**

There is an increased influence of electric applications in energy systems due to the shift from fossil fuels towards renewable energies which are mostly established in the electricity sector. Additionally, all energy sectors need to reduce carbon emissions to achieve set climate targets. One major contributor is the transport sector. Besides private vehicles other vessel types also have to be considered. One of them are waste collection vehicles (WCV). By defossilization of the vehicle drive system, the circular economy can contribute to the German and European climate goals in addition to the recovery of secondary raw materials (as described e.g. in [1]). According to the Federal Motor Vehicle Transport Authority (Kraftfahrt-Bundesamt, KBA), 13,748 WCV had been approved in Germany by January 1, 2019 [2]. The share of electric

drives in this sector is neglectable. By comparison, 1 % of the 33,000 public busses in Germany had an electric drive by February 2020 with an increase of up to 3 % to be expected by the end of the year [3]. This shows that there is already a momentum in some heavy-duty vehicle classes and that there is large potential for decarbonization of this vehicle class. First steps are already taken by switching from diesel-powered WCV (dWCV) towards gas-powered WCV (see e. g. [4]). However, taking into account the targets for greenhouse gas reduction electrification is a crucial step. Additionally, noise emissions that are an important issue for heavy-duty vehicles (cf. [5]) can be reduced, as electric drives are more muted, especially during driveaway [6].

The Berlin municipal waste management company (Berliner Stadtreinigung, BSR) is in the process of decarbonizing its vehicle fleet by replacing dWCV with eWCV, with its first pilot vehicle in testing since 2019 [7], [8]. Other municipal waste management companies are taking similar measures, e.g. in the cities of Vienna ([9]) or Gothenburg ([10]).

While battery capacity is still an important factor, in comparison to other heavy-duty vehicle applications waste collection has the advantage that tour length is seldomly above 80 km, easing these issues [11]. The collection duration for each tour lies within one work shift of eight hours. It is therefore also easier to implement a charging routine for these vehicle types. However, at the moment there are still high investment costs to consider. For example, the German government funded a study on eWCV, which proved them not to be an economically feasible option [12]. Due to their new market integration investment costs for eWCV are not yet published in list prices. Costs assumptions lie in the range of 400,000 € to 600,000 € for eWCV and 200,000 € to 250,000 € for dWCV [13]–[16]. Ewert et al. determined the total cost of ownership for a dWCV and eWCV fleet in Berlin by stating that an electrification of the WCV fleet increases the total costs of investment by 16-30 % [17].

It can be assumed that reduced battery investment costs will have a positive effect in the future. The introduction of electric series vehicles for heavy-duty together with subsidies might lead to high-volume production of corresponding batteries in the future. This will have a positive effect on battery prices. Nevertheless, an extension of the vehicle application range and the introduction of new revenue options can additionally facilitate broader market chances.

The fluctuation of renewable energies provides the option to increase turnover by acting grid-beneficial in regards to grid-to-vehicle (G2V), vehicle-to-grid (V2G) and vehicle-to-building (V2B) respectively, as shown e.g. in [19]. As discussed by Hu et al. this leads to the fulfilment of an overall social goal while at the same time is of self-interest [20]. There are several market mechanisms. One can be direct price incentives, that means increased electricity prices in times of load peaks and decreased ones during load valleys. There are several examples for models that consider this aspect. de Hoog et al. examine how a mechanism can consider grid-beneficial behavior and at the same time keep individual inclinations [21]. Khodayar et al. integrate EV fleets in day-ahead market scheduling [22]. Zoltowska and Lin develop a model to include electric vehicles in the wholesale market via an aggregator [23]. Sundström and Binding suggest a model that includes the interaction between aggregator, retailer and distribution service operator (DSO) [24]. All these studies have in common that they focus on market measures that can be taken by DSO or aggregators to increase grid-beneficial behavior. They show that there are several approaches available and discuss them for the private vehicle sector. No studies could be found that are concerned with the question of how fleet operators of electric heavy-duty vehicles could use existing mechanisms to increase the economics of their vessels.

While, depending on national and local market structures, it might not always be a suitable option for end-consumers to participate in the electricity market directly, load peaks by self-owned power appliances could be counteracted using electric vehicles as part of vehicle-to-building. This is shown e. g. by Tchagang and Yoo [25]. The economic aspects of V2G in combination with the reserve market are analyzed by Ciechanowitz et al for Germany in [26] and Kempton and Tomić for California in [27]. The authors conclude that an economic operation of V2G is handicapped by low prices for balancing power and high electricity prices. However, due to larger batteries and more flexibility concerning charging strategies within one single fleet, the situation might look different for eWCV.

Besides V2B/V2G options that are similar to those suitable for private vehicles - although on a larger battery scale - a special focus lies on eWCV that operate for thermal waste management (TWM) plants. The increased replacement of simple waste incineration by waste-to-energy (WTE) facilities worldwide as discussed e.g. by Kumar and Samadder in [28] leads to an interesting potential to increase eWCV economics. This is especially the case for developed countries with a low share of organics in the municipal solid waste and thereby high energy output (cf. [29]). Using WTE for ancillary services has been already discussed. Baran et al. look at the potential of the technology for Turkey with focus on its ability to stabilize the power grid as part of a smart grid [30]. The authors further examine the influence of a WTE plant within a microgrid that also includes a photovoltaic power plant [31]. However, the authors assume that municipal waste is collected in winter for usage in summer. This might not always be possible for operational reasons. Additionally, the focus of the research is on smart integration of WTE in a microgrid from a technical perspective. The economic potential is not considered. Ghaebi et al. introduce a microgrid that includes electric vehicle charging together with a WTE power plant. The authors examine the potential of the concept to take part in the Danish balancing power market. [32] It is found that in this case that by aggregating private vehicle charging stations there is a possibility of improved economics. eWCV are not analyzed in this study.

In general, until now, only few studies have been published that examine eWCV, none analyzing either charging strategies or participation in the balancing power market. At the research campus Mobility2Grid in Berlin (Germany), an overall concept for the electrification of public buses and waste disposal traffic has been developed [33]. As part of this initiative, Gräbener develops and evaluates the options for electrification of WCV as an example for service sector vehicles [34]. However, both, the report and the dissertation, do not include a simulation of the vehicle behavior in daily operation. Ewert et al. analyze the energy consumption of eWCV in Berlin using a multi-agent-based simulation [17]. An energy demand simulation is not presented in detail in the paper. Nagel et al. model waste collection by eWCV using a synthetic waste collection calendar but only assume mean energy demand values without conducting any detailed simulation [35]. Erdiñç et al. conduct an energy demand simulation of a 16 t eWCV in Istanbul, but only for a comparably short distance of 7 km and for 75 waste containers [36]. Schmid et al. simulate the energy demand of eWCV for different route types and distances giving a detailed description of the vehicle charging state after each tour [11].

Here, a case study with an operating WCV fleet and real-life data from waste treatment plants is conducted. The focus is on the potential grid relief, as well as economic benefits for the waste management companies. Thereby the study is the first of its kind that combines the question, how a grid-beneficial transformation towards eWCV can be achieved and additionally be a beneficial business case. The specific research tasks are as follows:

1. Analysis of eWCV charging and integration strategies, especially in connection with waste treatment plants
2. Analysis of market benefits by charging eWCV with the electric output of a TWM plant
3. Analysis, whether the participation in the balancing power market via G2V and V2G is economically beneficial
4. Analysis, whether using eWCV for peak shaving of loads by waste recycling plants is economically beneficial
5. Analysis of the manageability in operational process

The perspective of this study is the one of the fleet operator within the current electricity market framework. It is not considered how the DSO could influence grid-beneficial charging and discharging of eWCV by setting new price mechanisms. While the quantitative results are specific for this case study general conclusions about grid-beneficial and economic integration of eWCV can be reached.

The structure of the simulation model is shown in section 2. Different scenarios are established and simulated (section 3). The results are discussed in section 4.

## 2. Methods

In this section the developed model and the assumptions it is based on are detailed. The idea of the study is based on the fleet operators participating in the electricity market directly not using an aggregator. Therefore, a decentralized charging strategy as described for example by [37] is used and the vehicles are not connected to a virtual power plant. Although more than one eWCV is considered the charging strategy is not individual for each vehicle, but there is a single one for the overall fleet.

Figure 1 shows the general structure of the model applied in this study. It includes several submodels for the

1. vehicle battery
2. waste collection
3. lightweight packaging (LWP) sorting plant
4. AC and DC charging/discharging of eWCV
5. automatic frequency restoration reserve (aFRR) market in Germany/Austria
6. Storage management
7. network charges and surcharges

as well as the influence of the power grid by each submodel and vice versa. For the first two aspects the model introduced by Schmid et al. in [11] is used. There, a WCV vehicle fleet is simulated based on real-life operational data. This data includes different routes with varying length, number of stops and building types. Thereby, energy demand of WCV can be determined under different conditions. The considered waste recycling plant is a LWP sorting plant. The corresponding model is introduced in [18]. The TWM plant is not modelled in detail due to inconsistencies in the data given by the plant operators. Instead, it is assumed that the vehicle fleet can be charged fully by electricity output of the TMW. The economic specifics of this are considered within the submodel 'network charges and surcharges'.

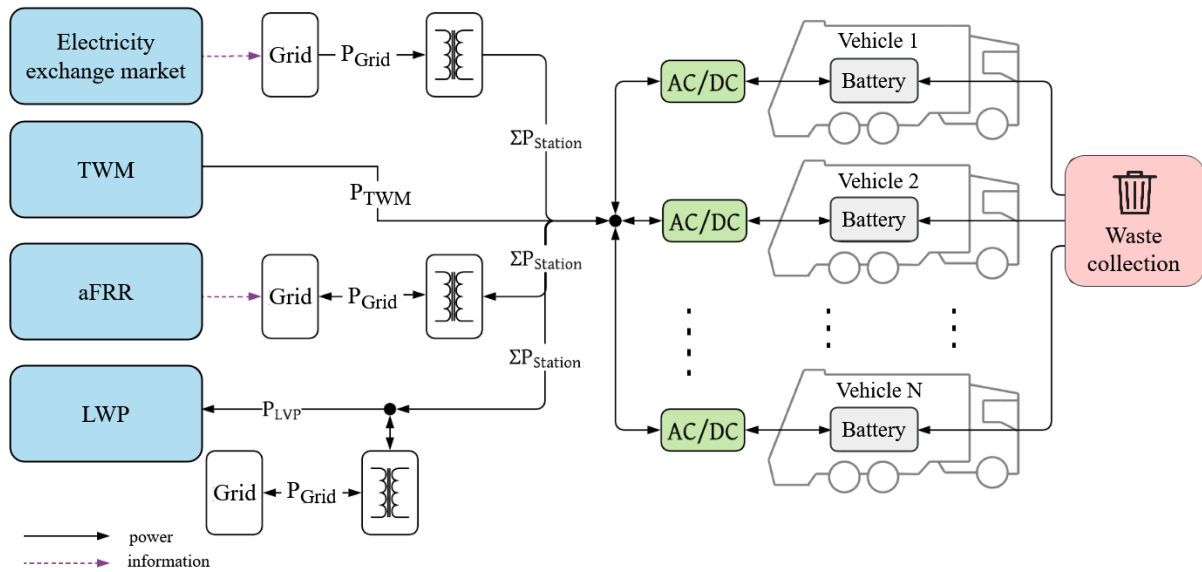

Figure 1: Model structure

Following the model structure of the remaining components is given.

## 2.1 Charge/discharge infrastructure

The model considers AC as well as DC charging with high power charging stations. For AC, charging stations in Mode-3 are used. Therefore, each eWCV needs a 44 kW electrical vehicle supply equipment (EVSE) and two AC onboard-chargers of 22 kW each. The onboard chargers are simplistically combined to one 44 kW charger in the model. For DC, charging stations with 100 kW are considered and no on-board charging infrastructure is taken into account. The following assumptions are applied to the model:

- Charging capacity is constant.
- Charging is interrupted when reaching the upper State-of-Charge (SOC) limit of the battery, discharging is stopped when reaching the lower SOC limit.
- For the AC and DC chargers as well as the EVSE the model given in [38] is used.
- For the bidirectional charging model parametrization the efficiency curve of a bidirectional AC charger given in [39], for the DC charging station the data from [40] is used.
- For the EVSE the efficiency curve given in [41] is considered.

The model for the AC and DC chargers and the EVSE is based on a 2<sup>nd</sup> degree polynomial using relative loads, meaning all considered loads are put in relation to the rated capacity. This makes it easier to scale the model. The parameterization is done using efficiency curves of inverters given by manufacturers together with empirical equations given in [38].

## 2.2 Balancing power market

Balancing power can be divided into three categories: frequency containment reserves (FCR), automatic frequency restoration reserves (aFRR) and manual frequency restoration reserves (mFRR). They each have different requirements for potential providers as stated in table 1.

For this case study the German reserve market and its preconditions are considered. As FCR had to be provided for a full week, when the study was conducted, it was deemed not suitable for eWCV. aFRR and mFRR have similar requirements. However, the revenues for aFRR are usually higher than for mFRR, therefore the focus lies on the former [42].

At the time of the study the minimum bid size for aFRR is 1 MW, for bids for either only positive or negative balancing power and not for both. Assuming charging stations with a standardized output of 44 kW, there is a minimum number of 23 electric vehicles necessary to fulfill this minimum size. DC charging with 100 kW lead to a minimum number of 10 WCV. To provide the marketable service over a period of four hours, the vehicles must always return to the charging station on time. However, a time buffer and safety precautions should be planned for safeguarding.

Table 1: Requirements for balancing power providers as of 01/2019 [29]

	<b>FCR</b>	<b>aFRR</b>	<b>mFRR</b>
Max. reaction time		30 s	5 min
Complete power after	30 s	5 min	15 min
Duration of bid call	Weekly	Daily	Daily
Product time slices	None (complete week)	6x4 hour blocks	6x4 hour blocks
Product differentiation	None	Positive/negative	Positive/negative
Min. bid size	1 MW	1 MW	1 MW
Tender acceptance	Capacity charge merit order	Capacity charge merit order	Capacity charge merit order
Compensation	Pay as bid (commodity price)	Pay as bid (capacity charge & commodity price)	Pay as bid (capacity charge & commodity price)

Following, the aspects that need to be considered when building a model for the German aFRR market are detailed. The revenue of the eWCV operator depends on the own bid as well as the competing ones. Therefore, the process that selects and reject bids has to be modelled in detail.

The offered balancing power must be provided over the complete time slice. For aFRR the offered bids (capacity charge (CaC) and commodity price (CoP) respectively) for Austria and Germany are combined to a joint merit order list (MOL). For that, for each bid an acceptance value (AV) is calculated as follows:

$$AV = CaC + WF \cdot CoP \quad (1)$$

The weighting factor WF is determined by the transmission system operator (TSO) and corresponds to the ratio of the load quantity requested to the total potential available quantity. It is published for each quarter. Additionally, since July 2018 the TSO also publishes anonymously the daily bids for aFRR. All accepted bids receive the offered CaC. In case of actual provision of balancing power, the offered CoP is paid additionally.

Historical data for the actual demand is given in 15 minutes steps in Austria with a positive or negative value for each step, compared with one-minute steps of either positive or negative value in Germany. Since both countries are part of one control area, it can be concluded that positive demand in Austria can only occur if the demand in Germany is also positive at the respective point in time. The same applies to negative demand. With this assumption, the average demand of Austria within a 15-minute block is divided according to the ratio of the summarized per-minute values in Germany.

The balancing power market is modelled as ex-post based on [43]. This means that publicly available historical data is used to determine the frequency of access and the revenue from a system. Therefore, the historical market for aFRR is considered, with following simplifications:

- Divergences from the MOL are not considered as they are not published.
- Ramping is not considered, the necessary power is available immediately, since batteries have a very short reaction time. The entire service delivered will then be remunerated.
- The own bid has a constant CaC and CoP for weekdays and weekend days respectively. As offering balancing power is not the main business of eWCV operators more dynamical bids are difficult to implement.
- The offered balancing power is always 1 MW.

For the study market data from 12 July 2018, 0:00h to 11 July 2019 23:59h is considered. The input is historical data of the expected demand of aFRR and the weighting factor for the analyzed period as well the historical real demand of aFRR and the historical MOL for each day. The user has to include the own bid. Whether it is accepted is evaluated for every day and every product by a bid function. Therein, both, days and products offered, are varied via loops. The own offer is inserted into the associated bid list. The acceptance value is calculated and the MOL is created. The corresponding expected demand, which serves as the limit value for the MOL, is also considered. If the user's own offer is below the limit it will be accepted. If it is above the limit it will be rejected. Only when the bid is accepted, it will be included in the retrieval pool.

A call function determines for each minute whether the system will be called. This is decided via a MOL of the CoP. The current demand represents the call limit. If the own offer is below the limit, a call is made. The algorithm then sets the trigger to one. Afterwards, the revenue from the CoP obtained through the call is calculated. The model structure is shown in figure 2.

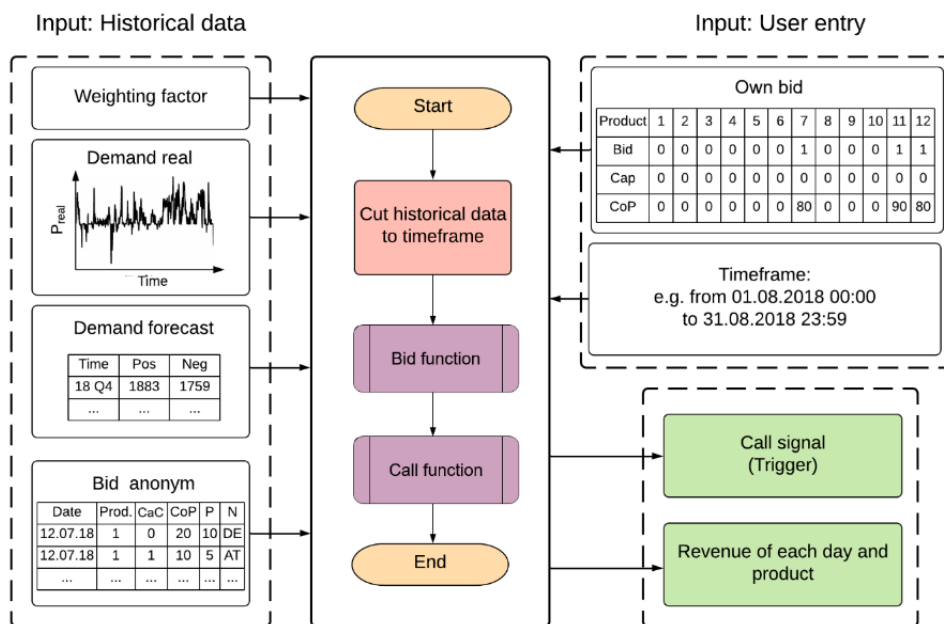

Figure 2: Scheme of the aFRR model.

## 2.3 Storage management

First, only the storage management for the provision of aFRR is considered. Management takes place via charging/discharging processes through scheduled transactions. To prevent the storage from being completely charged or discharged and thereby being unable to provide balancing power, energy is bought or sold on the intraday market at short notice. Purchases on the day-ahead market are also considered. This is to avoid the extreme price peaks of the intraday market.

Electricity trade on the intraday market is simplified for this model. The intraday index is converted into €/kW for every minute and it is assumed that any amount of energy can be taken from the grid or fed into the grid at any minute, as long as only the corresponding index is paid. The lead time of at least 5 minutes is neglected, as well as the prescribed smallest unit of 0.1 MW to be traded and the smallest unit of time for a delivery of 15 minutes. Thereby, the complexity of the model and accordingly the computing time is reduced, while its overall validity persists. The same assumptions are made for day-ahead trading as for intraday trading.

To develop the storage management algorithm, the various general options for the provision of aFRR with a battery storage are considered. This results in binding SOC limits for a battery storage system that provides aFRR. It turns out that the strict application of these mandatory limits is not expedient for reaching the upper SOC limit at the start of the waste collection phase. To enable unrestricted waste collection and continuous aFRR provision, optional SOC limits for buying and selling are defined. They are included in the model if necessary.

The vehicle battery can never be fully loaded via aFRR, as the load depends on the frequency of calls. Therefore, in all scenarios with balancing power, two hours are scheduled before each collection phase in which the vehicles are to be fully charged. To avoid catch-up effects, the electricity is purchased on the intraday market. Due to the difference between the energy consumption of the different routes, the vehicles also return with very different SOC. To keep the number of purchases as low as possible, the batteries are balanced to a similar SOC before the start of the aFRR phase. The period between 2 pm and 4 pm can be used for this.

## 2.4 Network charges and surcharges

Network charges and surcharges have a significant influence on the profitability of grid-beneficial operation. In Germany, the electricity price is set by an interaction of these together with CaC and CoP. Large consumers have to provide an individual load profile, which leads to different network charges compared to consumers on a standard load profile. Table 2 shows the specific surcharges as well as the network charges for load profile customers and the wholesale price for the provision of aFRR for 2019.

Table 2: Specific charges, surcharges and service costs for aFRR in 2019 [31]–[33].

	Unit	Value	Remark
Annual CaC (L <sub>AM</sub> < 2500) <sup>1</sup>	€/kW/a	3.94	Battery storages are exempted → not applicable to V2G
Annual CaC (L <sub>AM</sub> > 2500)	€/kW/a	43.43	
CoP (L <sub>AM</sub> < 2500)	ct/kWh	3.33	
CoP (L <sub>AM</sub> > 2500)	ct/kWh	1.75	
Metering point operation charge	€/a	439.92	
EEG <sup>2</sup> surcharge	ct/kWh	6.405	Electricity from plants stated in EEG only 40 % surcharge in case of own consumption EEG

<sup>1</sup> L<sub>AM</sub>: Annual maximum load

<sup>2</sup> EEG: Erneuerbaren-Energien-Gesetz (Renewable Energy Act)



			Storage losses and stored energy up to 500 kWh per kWh storage that is fed back to the grid are exempted
KWK <sup>3</sup> surcharge	ct/kWh	0.28	Exemptions analogous to EEG surcharge
StromNEV <sup>4</sup> surcharge (group A)	ct/kWh	0.305	Surcharge for costs for the partial exemption of large electricity consumers from grid charges in case of so-called atypical grid usage Group A defines costs for first 1,000,000 kWh consumed electricity
StromNEV surcharge (group B)	ct/kWh	0.05	Group B defines costs for consumed electricity above 1,000,000 kWh
Offshore-grid surcharge	ct/kWh	0.416	Exemptions analogous to EEG surcharge
AblaV <sup>5</sup> surcharge	ct/kWh	0.005	Surcharge for costs due to compensation of industrial consumers in case of power disconnection by the grid operator to ensure overall power security
Concession fee	ct/kWh	0.13	Assumption according to § 2 par. 7 KAV: reduced fee is to be paid
Electricity tax	ct/kWh	2.05	Assumption: electricity fed to the grid from batteries are tax exempted Tax exemption for electricity from plants stated in EEG
Price for electricity from TWM plant	ct/kWh	38	Assumption based on statements by plant operator

## 2.5 Price determination for aFRR

Continuous forecasts of the balancing power market are not possible for a system that only provides the minimum demand and has limited capacity for participation in the balancing power market. Therefore, knowledge about the level of demand must be obtained based on the historical data.

As a first step an ex-post simulation is used to calculate the annual revenues that can be achieved by increasing the CaC in steps of 5 €. Furthermore, since the CoP also influences the award (see equation (1)), it also has to be considered. It is therefore set at 80 € for positive and 0 € for negative offers. However, the revenues from the CoP are not included in the evaluation of potential revenues.

Figure 3 shows the results of the analysis. The maximum revenue is achieved with a CaC of 10 €/MW. As this price rises, offers are more often rejected, i.e. not awarded. Therefore, revenues fall after this maximum. But even in the optimum case the CaC leads to some products being rejected 60% of the time.

Since the revenues from CaC are significantly lower than those from CoP, a high rejection rate can result in heavy losses in CoP revenues. It is therefore advisable to forego CaC and accordingly they are offered at 0 €.

<sup>3</sup> KWK: Kraft-Wärme-Kopplung ('Combined heat and power')

<sup>4</sup> StromNEV: Stromnetzentgeltverordnung ('Electricity Grid Fee Ordinance')

<sup>5</sup> AbLaV: Verordnung zu abschaltbaren Lasten 'Ordinance for Interruptible Loads')

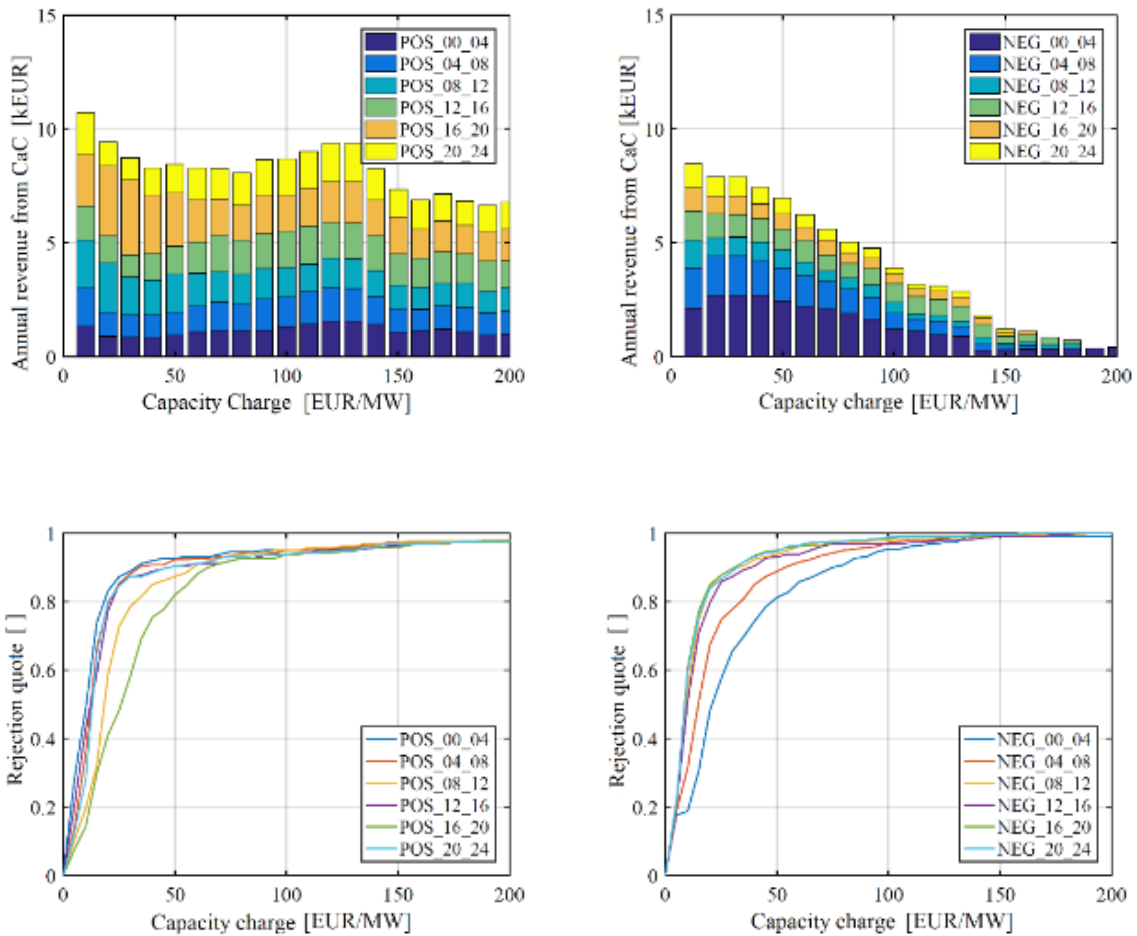

Figure 3: Annual revenues and rejection quotes depending on CaC for positive (left) and negative (right) balancing power bids

In the second step the achievable revenue through the CoP is determined. For this, it is varied, while the CaC is set to zero. In addition to the revenue, the relative call duration, i.e. the ratio of minutes called to total minutes, is determined. Figure 4 shows the results. The maximum revenue for positive products is achieved with the lowest CoP. Such an offer is always at the lower end of the MOL and is therefore most frequently requested. With a daily CoP of 60 €, a revenue of approx. 44,500 € can be generated within just one time slice. Since power plants can save fuel by providing negative balancing power, the plant operators accept negative CoP. Therefore, the highest frequency of retrieval occurs at an energy price of -50 €. However, the maximum revenue is achieved with the highest CoP.

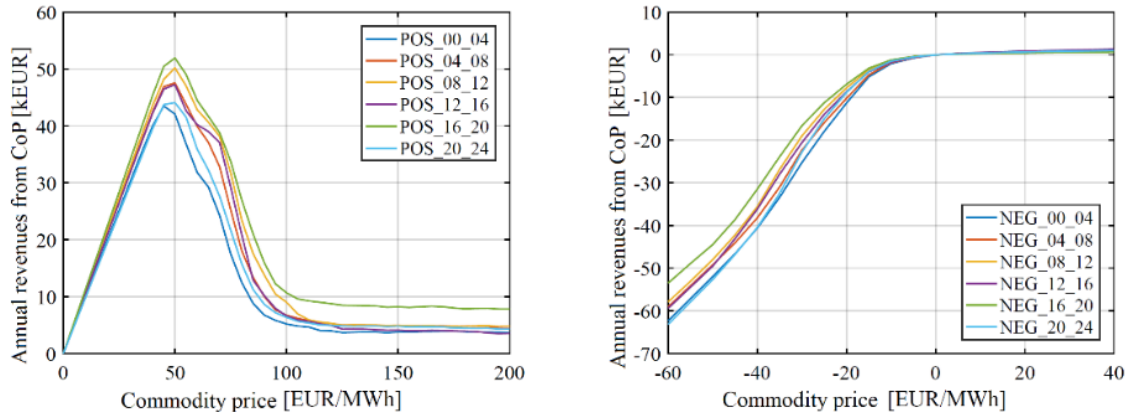

Figure 4: Annual revenues depending on CoP for offering positive (left) and negative (right) balancing power

The extra costs for providing aFRR with a fleet of electric refuse collection vehicles depend on their charge status. For the energy required for charging, the wholesale price and final consumer taxes are paid. The average intraday index of the period under consideration is used as the wholesale price to determine the supply costs. This is 45.6 €/MWh. The final consumer taxes do not have to be included in the delivery costs if the balancing power occurs during the charging phase after collection. The reason for this is that these taxes would also have to be paid without balancing power. If the vehicles are already charged, when the own bid is called neither charging nor discharging would take place without the balancing power being called up. Therefore, in such a case, the final consumer taxes cannot be neglected. However, not all surcharges, fees and taxes have to be taken into account: assuming that the vehicle batteries work as storages no surcharges have to be paid. Also, the annual CaC and the metering point operation charge can be neglected as they have to be paid even without balancing power. Therefore, the calculation of is reduced to the CoP of the network charges, concession fees, electricity tax and sales tax. The sales tax must also be added to the wholesale price in case of electricity purchases.

If positive aFRR is provided during the charging process, this must be interrupted when requested. However, the wholesale price for the purchased electricity must still be paid because it has been bought regardless whether there is real demand. Therefore, in such a case the supply costs correspond to the wholesale price and the applicable sales tax. If the vehicles are fully charged, they would have to be recharged after positive balancing power has been provided. The costs for recharging consist of the sum of the wholesale price, sales tax and end-user taxes and in this case represent the supply costs. If the batteries are supposed to produce negative aFRR after they have already been charged, they must first be partially discharged again, which generates revenue. During the provision, however, final consumer taxes are incurred. The delivery costs result from the final consumer taxes minus the wholesale price.

The profit by aFRR results from the proceeds minus the delivery costs. For the cases of charged and uncharged vehicles that are considered for positive and negative aFRR, they are dependent on the CoP. There are clear maxima for uncharged vehicles, which are used in the following simulation as the CoP (see Figure 5).

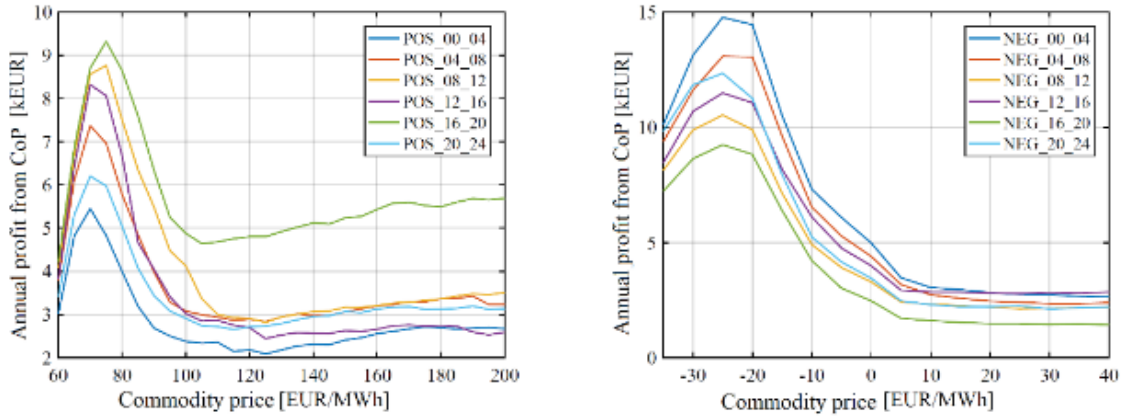

Figure 5: Annual profits depending on the CoP for uncharged vehicles for offering positive (left) and negative (right) balancing power

For vehicles that have already been charged, the maximum is the highest CoP due to the high final consumer taxes. A CoP of 200 € must be selected for all positive products and of 40 € for negative products (see figure 6).

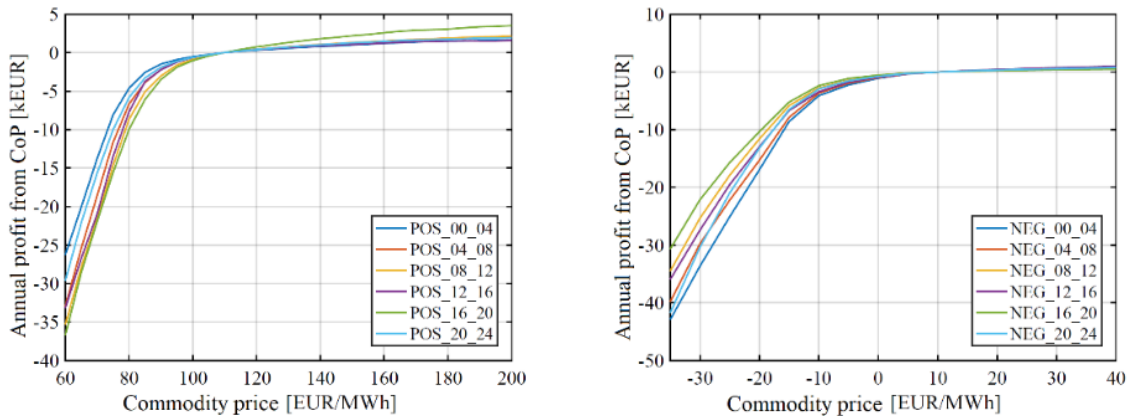

Figure 6: Annual profits depending on the CoP for charged vehicles for offering positive (left) and negative (right) balancing power

In the scenarios described below, in which only positive or negative aFRR is offered, these optimized CoP can be used. On weekdays the prices for unloaded vehicles are considered and on weekends the prices for already loaded vehicles. The fact that the vehicles can be fully charged even on weekdays before the end of the aFRR phase is initially neglected when estimating the CoP.

In the case of alternating positive and negative aFRR, the achievable profits are influenced by the CoP of the products with the other sign. The aim is to generate profits through positive aFRR due to the higher prices. To do this, the vehicles have to be unloaded. In the following time slice, the vehicles should then be charged again as cheaply as possible via negative aFRR. Therefore, in the following consideration, two products, a positive and the subsequent negative are considered together. There are costs that are incurred when a negative aFRR is called up and only depend on the offered CoP of the negative product time slice. In addition, there are costs associated with purchases and sales on the electricity market. These depend on the working prices of both products and are negative for sales.

### 3. Scenarios

Various scenarios for the grid-beneficial integration of eWCV are designed. In a first scenario, the simple charging of the vehicles A1 and a direct charge via a TWM plant A2 are considered. The provision of negative (B1) and positive (B2) aFRR is investigated in scenario B. In addition, the effects of negative aFRR on weekdays and alternating positive and negative aFRR on weekends using AC chargers B3 or DC charging stations B4 are examined. In the third scenario C the coupling of eWCV with the LWP sorting plant is analyzed. The overall goal of all scenarios is to increase profitability, also by providing balancing power and lowering peak loads.

Due to the different collection routes, some vehicles consume more energy than others during the collection and therefore must be charged for a longer time. The losses are therefore also dependent on the vehicle. For better comparability of the scenarios, the same 23 routes from three different route types with an average electricity consumption of 16.258 MWh/year during collection are used for all scenarios besides B4. As only 10 vehicles are necessary to provide the minimum aFRR in scenario B4 the number of selected routes are reduced accordingly. The average electricity consumption in this scenario is 17.140 MWh/year. All scenarios are assessed based on the resulting charging costs and feasibility. Due to the different collection routes, some vehicles consume more energy than others during the collection and therefore must be charged for a longer time. The losses are therefore also dependent on the vehicle. For better comparability of the scenarios, the same 23 routes from three different route types with an average electricity consumption of 16.258 MWh/year during collection are used for all scenarios besides B4. As only 10 vehicles are necessary to provide the minimum aFRR in scenario B4 the number of selected routes are reduced accordingly. The average electricity consumption in this scenario is 17.14 MWh/year. All scenarios are assessed based on the resulting charging costs and feasibility.

Table 3 states the CoP used for each time slice during weekdays and weekends for each scenario. Due to the different collection routes, some vehicles consume more energy than others during the collection and therefore must be charged for a longer time. The losses are therefore also dependent on the vehicle. For better comparability of the scenarios, the same 23 routes from three different route types with an average electricity consumption of 16.258 MWh/year during collection are used for all scenarios besides B4. As only 10 vehicles are necessary to provide the minimum aFRR in scenario B4 the number of selected routes are reduced accordingly. The average electricity consumption in this scenario is 17.14 MWh/year. All scenarios are assessed based on the resulting charging costs and feasibility.

Table 3: Offered CoP for aFRR for all time slices during weekday (WD) and weekend (WE).

	Negative aFRR						Positive aFRR					
	0-4 h	4-8 h	8-12 h	12-16 h	16-20 h	20-0 h	0-4 h	4-8 h	8-12 h	12-16 h	16-20 h	20-0 h
B1 WD	-25	/	/	/	-25	-25	/	/	/	/	/	/
B1 WE	40	40	40	40	40	40	/	/	/	/	/	/
B2 WD	/	/	/	/	/	/	70	70	75	70	75	70
B2 WE	/	/	/	/	/	/	200	200	200	200	200	200
B3 WD	-25	/	/	/	-25	-25	/	/	/	/	/	/
B3 WE	/	40	/	40	/	/	160	/	160	/	160	/
B4 WD	0	/	/	/	0	0	/	/	/	/	/	/

B4 WE	/	40	/	40	/	/	160	/	160	/	160	/
-------	---	----	---	----	---	---	-----	---	-----	---	-----	---

## 4. Results and Discussion

This section presents the obtained simulation results with a detailed analysis of energy values and overall costs per vehicle of all considered scenarios.

### 4.1 Energy and losses

Table 4 shows the electricity consumption, provision and losses based on the selected 23 and 10 collection routes respectively. Besides the overall energy values that consider G2V and V2G and total losses, specific numbers for the aFRR phases and the amount of energy bought and sold at the intraday and day ahead market are given.

In scenarios A1 and A2, the energy used only serves to cover the load necessary for waste collection and neither is electricity fed to the grid nor is aFRR provided. Since it is used just for charging the eWCV the lowest amount of electricity compared to scenarios B and C is provided by the grid.

Losses (column C) are calculated by comparing the power from grid to vehicle and vice versa with the battery charging state. Due to the reduced amount of charging and discharging cycles in scenarios A1 and A2 the losses are less compared to the other scenarios.

Not considering the power for aFRR, the energy drawn in scenarios B1 to B3 are comparable to C with 28 – 32.5 MWh/(a\*WCV) electricity supplied by the grid (column A – column D) and 8 – 12.5 MWh/(a\*WCV) given to the grid or the LWP sorting plant (column B – column E).

Table 4: Detailed overview on energy values of all considered scenarios in MWh/(a\*WCV), including energy bought and sold at intraday (ID) and day ahead (DA) market.

	A	B	C	D	E	F	G	H
	G2V	V2G	Loss	aFRR_Neg	aFRR_Pos	Purchase_ID	Purchase_DA	Sale_ID
A1	18.356	0.000	-2.086	0.000	0.000	0.000	18.356	0.000
A2	18.356	0.000	-2.086	0.000	0.000	0.000	0.000	0.000
B1	88.566	-11.022	-5.061	56.259	0.000	7.336	0.000	-42.311
B2	28.789	-46.982	-4.362	0.000	-38.820	59.447	0.000	0.000
B3	88.026	-12.043	-5.114	55.447	-0.801	7.592	0.000	-40.901
B4	57.674	-14.858	-9.101	18.48	-1.843	30.212	0.000	-20.67
C	32.33	-12.432	-3.694	0.000	0.000	0.000	32.330	0.000

This is due to the framework of these scenarios: for B it is necessary to charge/discharge the vehicles in such a way that the provision of aFRR is possible, even if it is not called up. In scenario C energy is used to supply the LWP sorting plant during peak loads, therefore increasing the power that needs to be provided by the grid. As the electricity supplied by and fed to the eWCV are of similar magnitude, the overall losses are also similar.

These results are not applicable to scenario B4. Here, the energy drawn from or supplied to the grid is around 20 % higher compared to the other scenarios in B. This is mainly due to higher losses that can be traced back to the higher charging capacity of 100 kW.

In A1, all the energy required is purchased on the day-ahead market. Since the vehicles in A2 are charged with electricity from the TWM plant, no energy has to be purchased on the electricity market. For scenarios B it is also shown how much of the energy bought on the

intraday market is drawn during the remaining charging phase. This shows to what stage the vehicles are really charged using aFRR and how much additional energy has to be purchased.

In B1, each vehicle provides around 56 MWh/(a\*WCV) of negative aFRR, of which around 42 MWh/(a\*WCV) are sold again. The remaining energy is consumed by the vehicle during the waste collection. 7.5 MWh/(a\*WCV) must be purchased separately for each vehicle. A comparison with scenario A1 shows that more than three quarter of the energy required for waste collection comes from aFRR. The remaining energy as well as losses are covered directly by the grid. To ensure the requirements for aFRR provision are fulfilled around 11 MWh/(a\*WCV) is fed back to the grid.

In B2 there are around 39 MWh/(a\*WCV) of positive aFRR. However, 60 MWh/(a\*WCV) have to be purchased for this. 3.38 MWh/(a\*WCV) are bought for the remaining charge. Due to the high CoP offered on weekends, the majority of the total demanded aFRR is provided on weekdays. Therefore, B1 and B3, which only differ on weekends, are very similar. In B4, due to the higher offered energy prices compared to B1 and B2, significantly less aFRR is called up and more energy has to be purchased during the remaining charge. Due to the daily reduction of the SOC to 0.5 before the provision of aFRR, significantly more energy is fed back in comparison with the other scenarios. As a result, more energy has to be drawn from the grid. Therefore, during the remaining charge even more energy has to be purchased than in scenario A1.

In C approx. 2/3 of the supplied energy is used for balancing the electricity consumed during the collection and the corresponding losses. The remaining is used during peak loads of the LWP sorting plant.

## 4.2 Overall costs

Figure 7 shows the breakdown of costs into the different categories that have to be considered for each scenario. Following they will be discussed in detail.

In A1 and C, the wholesale price consists only of the electricity price paid on the day-ahead market. In A2, this is the price to be paid to the TWM plant operator. In the sub-scenarios of B, a distinction must be made between purchases and sales and aFRR revenues. Although positive balancing power in B2 generates a very high revenue, higher costs are incurred through intraday purchases. In B1 and B3, the costs for negative aFRR are significantly higher than the wholesale price of scenario A1. However, since the excess energy is resold, this can be balanced and the wholesale price becomes negative, but also almost negligible. The same applies to B4. Since most calls are made on weekdays, the wholesale prices of B1 and B3 are almost identical.

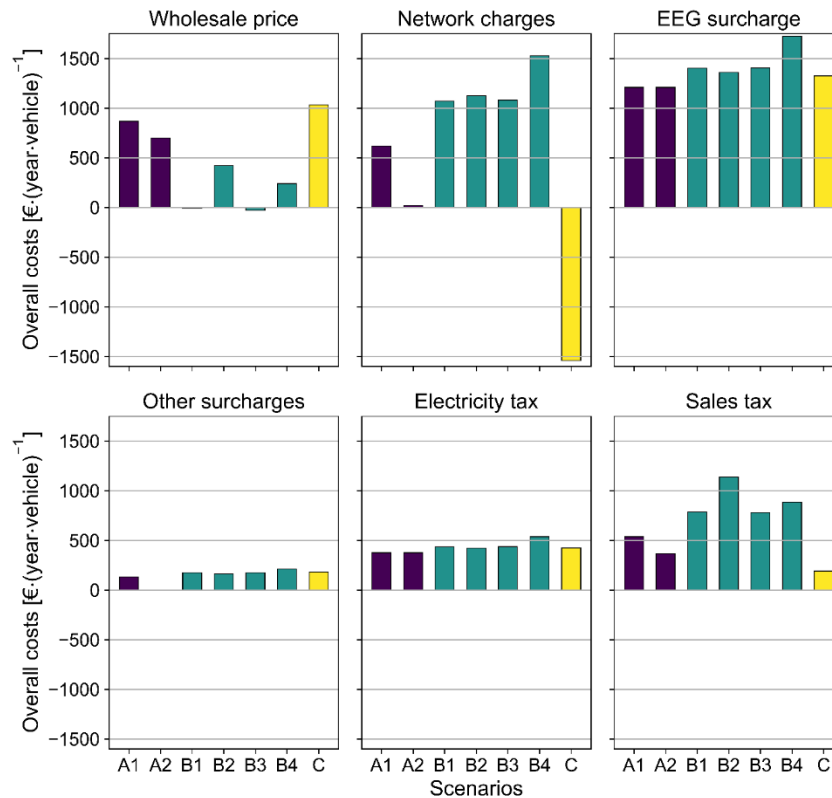

Figure 7: Composition of costs for each scenario

Looking at network charges, there are sometimes significant differences. Because there is self-sufficiency in A2, the network charges do not apply, except for the costs of measuring point operation. In B significantly more energy is used than in A1, which is why the network charges are significantly higher. The short period of use, which goes hand in hand with low performance and high CoP, also means that there is no atypical network usage in B (apart from B1). The savings of the sorting system due to atypical network usage, which is enabled by the eWCV, result in a negative network charge in C.

The EEG surcharge is lowest in A. Due to offsetting, the scenarios with V2G are not significantly higher. There is no offsetting in C because no V2G is practiced. However, the EEG surcharge is very low, since it is included for charging of the vehicles and for the losses. The EEG surcharge for the withdrawal is allocated to the LWP sorting plant

StromNEV surcharge, offshore-grid surcharge, Ablav surcharge and concession fee do not apply to A2 due to self-sufficiency. The value is higher in scenarios with a higher annual load. It is lowest in A1. Electricity tax also increases with the annual load. Since offsetting is also done here, the deviations between the scenarios are low.

Regarding sales tax, there are very large differences depending on the scenario. C has the lowest value because savings in sales tax on the network charges of the LWP sorting plant are considered. In A1 and A2, only the electricity purchased and the final consumer tax are subject to sales tax. Due to the additional transactions in B, higher sales taxes have to be taken into account. Significantly more purchases are made in B3, which also results in a higher sales tax.

The overall costs per vehicle and year are shown in Figure 8. In the base scenario, the annual charging costs per vehicle are appr. 3750 €. Through self-supply A2 this price can be reduced



to around 2,700 €. The cheapest annual costs are at 1619 € in C. In B there is no improvement in costs. However, in B1 and B3, the charging costs are only slightly above those of A1.

The prices of B can be traced back to the high share of V2G. This is caused by the unexpectedly low energy consumption during the collection phase. This was not taken into account when the offers were generated. Therefore, for B1, further simulations are carried out at higher CoP. The offers for weekends are not changed. For weekdays, the prices are increased in 10 € intervals. As the CoP rises, fewer calls are made. This reduces the aFRR costs. However, less energy can be sold, which is why these revenues decrease and more energy has to be purchased for the remaining charge. The wholesale price therefore rises with higher CoP.

However, the surcharges decrease due to the lower V2G share. This is particularly evident in the network charges. Sales tax will also be greatly reduced. Therefore, the total costs decrease despite rising wholesale prices. From a CoP of -5 €/MWh the increase in the wholesale price outweighs the savings in final consumer taxes and the total costs increase. The calculations are therefore carried out for a CoP of -5 €/MWh. The charging costs per vehicle can be reduced to 3551 €/year. It also shows that much less aFRR can be offered this way.

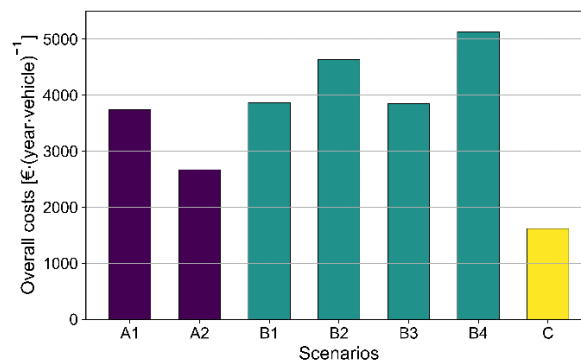

Figure 8: Overall costs for different scenarios

### 4.3 Assessment of scenarios

In A2 the costs are reduced by more than 1000 € per vehicle and year compared to the base scenario A1 assuming constant losses and aging. Therefore, if there is the possibility to charge the vehicles directly via an own electricity generation system, this is highly recommended for economic reasons. In addition to the TWM plant, a biogas or PV plant would also be conceivable. In these cases, the EEG surcharge would also be partially eliminated.

Regarding scenario B, various factors prevent profitability. On the one hand, the network charges are decisive for this. Since the storage privileges are not applicable to V2G, the network charges are significantly above the base scenario. Despite the offsetting due to the storage privileges, all other surcharges and the electricity tax due to the increasing losses at V2G are above those of A1. The purchase and sale of energy is simplified in the storage management function without considering the current prices. Due to the sometimes large fluctuations in intraday prices, better results could be expected with an optimized purchase and sale. However, the main problem with scenario B is the acceptance of static offers. The balancing power market is too volatile to be able to assert itself with storage and static offers. This is particularly evident in the results of B1 with higher CoP. Therefore, a connection to an aggregator or a power plant pool would be strongly recommended. These usually work with

market forecasts. In this way, optimal CoP can be offered, and profits can be made through CaC that have so far been neglected. The minimum number of vehicles and the organizational effort also speak in favor of connecting to a pool.

Higher prices due to the introduction of a balancing commodity market as already discussed (see [44]) and an increasing need for balancing power due to the increasing use of renewable energies could improve the market situation in the future. However, such developments are influenced by too many factors to be able to make a meaningful forecast in the context of this study. Despite all negative aspects of the scenario, the provision of aFRR can be integrated into the operational process of waste collection and that the vehicles can provide large amounts of balancing energy without failures in the collection operation.

The lowest charging costs are achieved in C. In contrast to B, it is particularly advantageous that neither a connection to a pool nor special market knowledge would be necessary. Another advantage of this scenario is that atypical network use of the sorting system can be achieved with just 10 vehicles. Therefore, the vehicles could be bought gradually and peaks loads could be reduced annually with additional vehicles. This strategy could be a grid-beneficial contribution.

## 5. Conclusion

This paper analysis, how eWCV can be used grid-beneficially. For that different scenarios look at the balancing power market as well as the integration of eWCV with waste treatment plants. Besides the question, how these scenarios can be advantageous for the grid, another is, how the economics of eWCV can profit from them.

The results show that a combination of eWCV with waste plants to reduce peak loads can reduce the charging costs by more than a half. Also, it is beneficial to use TWM power generation plants for charging the vehicles. Depending on the levelized costs of electricity using self-owned renewable power plants, e.g. photovoltaic plants, can lead to further economic improvements. The balancing power market is not a viable option for a fleet operator, as it is necessary to give the participation in this market a lot of attention. This is not possible in daily operation. The introduction of a balancing commodity market might lead to new options in the future.

Overall, the introduced paper shows that eWCV have a high potential to be grid-beneficial. However, the current regulations and frameworks make it unattractive for fleet operators to look at more advanced options to participate in the electricity market.

While the quantitative economic results of this study are specific for the analyzed case and area, the general conclusions are applicable for other markets. Additionally, the values found for the energy demand of eWCV and thereby their potential to take part in the balancing power market at all can be transferred to other locations with similar topological conditions.

Therefore, this paper opens the way to further studies that are planned for the future. The model will be extended, so that it includes an optimization to find the ideal CoP depending on vehicle energy consumption during collection, number of calls for aFRR, wholesale price and V2G share. One important aspect to be considered in future is the integration of the vehicle fleet in a balancing power pool. While this has several advantages, e.g. more options for dynamic bidding, there might also be operational and economical limitations that have to be considered carefully. Also, the influence of faster battery aging due to more cyclical loading on the charging economics needs to be integrated in the model and evaluated. Finally, the

installment of on-side renewable energy plants can have positive effects on the economics as well as the loads on the grid. This is a further model extension to be implemented.

## 6 Acknowledgments

The study 'Netzdienliche Integration hybrider Entsorgungsfahrzeuge' (Grid-beneficial Integration of Hybrid Waste Collection Vehicles) was funded by the Berlin Senate and the European Regional Development. The current paper builds on the experiences made in this study, of which the authors were part of. The authors thank all partners of this study.

## References

- [1] A. Gallego-Schmid, H. M. Chen, M. Sharmina, and J. M. F. Mendoza, "Links between circular economy and climate change mitigation in the built environment," *Journal of Cleaner Production*. 2020, doi: 10.1016/j.jclepro.2020.121115.
- [2] "Fahrzeugzulassungen (FZ 25)," 2019. [Online]. Available: [https://www.kba.de/SharedDocs/Publikationen/DE/Statistik/Fahrzeuge/FZ/2019/fz25\\_2019\\_pdf.pdf?\\_\\_blob=publicationFile&v=8](https://www.kba.de/SharedDocs/Publikationen/DE/Statistik/Fahrzeuge/FZ/2019/fz25_2019_pdf.pdf?__blob=publicationFile&v=8).
- [3] Verband Deutscher Verkehrsunternehmen (VDV), "E-Busse im ÖPNV," 2020. <https://www.vdv.de/elektromobilitaet-im-oepnv.aspx>.
- [4] Umweltbundesamt, "Berliner Stadtreinigung: Fahrgestelle mit Erdgasmotor," 2016. <https://www.umweltbundesamt.de/themen/wirtschaft-konsum/umweltfreundliche-beschaffung/gute-praxisbeispiele/kommunalfahrzeuge-omnibusse/berliner-stadtreinigung-fahrgestelle-erdgasmotor> (accessed Aug. 21, 2020).
- [5] M. Klopfer, B. Griefahn, and A. M. Kaniowski, *Leben mit Lärm?: Risikobeurteilung und Regulation des Umgebungslärms im Verkehrsbereich*, 1. Aufl., vol. 28. Berlin, Heidelberg: Springer-Verlag, 2006.
- [6] FAUN Umwelttechnik GmbH & Co. KG, "HYDROPOWER, E-POWER und DUALPOWER." [https://www.faun.com/wp-content/uploads/2017/05/fuo\\_prospekt\\_ECO-Option\\_4s\\_low.pdf](https://www.faun.com/wp-content/uploads/2017/05/fuo_prospekt_ECO-Option_4s_low.pdf).
- [7] "Energiezukunft," 2018. <https://www.energiezukunft.eu/mobilitaet/vorreiter-fuer-e-mobilitaet/>.
- [8] "DGAW e.V.," 2019. <https://www.dgaw.de/wp-content/uploads/DGAW-Pressemitteilung-Alternative-Antriebe-final.pdf>.
- [9] Webredaktion, "Erstes Elektro-Müllsammelfahrzeug Österreichs in Betrieb." <https://www.wien.gv.at/umwelt/ma48/fuhrpark/elektro-muellsammelfahrzeug.html> TS - Microsoft Word (via sources.xml) M4 - Citavi.
- [10] C. Rosengren, "Volvo unveils another electric refuse collection vehicle," 2019. <https://www.wastedive.com/news/volvo-launch-fully-electric-collection-vehicle-europe/521611/>.
- [11] F. Schmid, L. Taube, J. Rieck, and F. Behrendt, "Electrification of waste collection vehicles: Techno-economic analysis based on an energy demand simulation using real-life operational data," 2020.
- [12] B. G. Wilson and B. W. Baetz, "Modeling Municipal Solid Waste Collection Systems Using Derived Probability Distributions. I: Model Development," *J. Environ. Eng.*, vol. 127, no. 11, pp. 1031–1038.
- [13] J. Stender, "Hybrid-Müllwagen rollt leise zum Test durch Gelsenkirchen," 2017.

- <https://www.waz.de/staedte/gelsenkirchen/hybrid-muellwagen-rollt-leise-zum-praxistest-id211761761.html>.
- [14] I. Höltmann, "Berliner BSR - Was kostet eigentlich ein Müllwagen." <https://www.tagesspiegel.de/wirtschaft/berliner-bsr-was-kostet-eigentlichein->.
- [15] e-mobil L. für E. und B. B.-W. GmbH, Ed., "Nullemissionsnutzfahrzeuge: Vom ökologischen Hoffnungsträger zur ökonomischen Alternativ." <https://www.emobil-sw.de/fileadmin/media/e-mobilbw/Publikationen/Studien/NFZ-Studie.pdf>.
- [16] Y. Zhao and O. Tatari, "Carbon and energy footprints of refuse collection trucks: a hybrid life cycle evaluation," *Sustain. Prod. Consum.*, pp. 180–192.
- [17] R. Ewert, A. Grahle, K. Martins-Turner, A. Syré, K. Nagel, and D. Göhlich, "Electrification of Urban Waste Collection: Introducing a Simulation-Based Methodology for Feasibility, Impact and Cost Analysis," *TRB Annual Meeting*. Washington DC TS - Microsoft Word (via sources.xml) M4 - Citavi, 2020.
- [18] L. Taube *et al.*, "Contribution of Waste Management Companies towards a Flexible Energy System Using Sector Coupling," in *Proceedings International ETG-Congress 2019*, Esslingen: VDE TS - Microsoft Word (via sources.xml) M4 - Citavi, 2019.
- [19] M. Landau, J. Prior, R. Gaber, M. Scheibe, R. Marklein, and J. Kirchhof, "Technische Begleitforschung Allianz Elektromobilität - TEBALE Abschlussbericht," p. 143.
- [20] Z. Hu, K. Zhan, H. Zhang, and Y. Song, "Pricing mechanisms design for guiding electric vehicle charging to fill load valley," *Appl. Energy*, vol. 178, pp. 155–163, Sep. 2016, doi: 10.1016/j.apenergy.2016.06.025.
- [21] J. De Hoog, T. Alpcan, M. Brazil, D. A. Thomas, and I. Mareels, "A Market Mechanism for Electric Vehicle Charging under Network Constraints," *IEEE Trans. Smart Grid*, vol. 7, no. 2, 2016, doi: 10.1109/TSG.2015.2495181.
- [22] M. E. Khodayar, L. Wu, and Z. Li, "Electric vehicle mobility in transmission-constrained hourly power generation scheduling," *IEEE Trans. Smart Grid*, vol. 4, no. 2, 2013, doi: 10.1109/TSG.2012.2230345.
- [23] I. Zoltowska and J. Lin, "Availability Bids Enabling Participation of Electric Vehicles in the Wholesale Markets," 2019, doi: 10.1109/EV.2019.8893006.
- [24] O. Sundström and C. Binding, "Flexible charging optimization for electric vehicles considering distribution grid constraints," *IEEE Trans. Smart Grid*, vol. 3, no. 1, 2012, doi: 10.1109/TSG.2011.2168431.
- [25] A. Tchagang and Y. Yoo, "V2B/V2G on energy cost and battery degradation under different driving scenarios, peak shaving, and frequency regulations," *World Electr. Veh. J.*, vol. 11, no. 1, 2020, doi: 10.3390/WEVJ11010014.
- [26] D. Ciechanowicz, M. Leucker, and M. Sachenbacher, "Ökonomische Bewertung von Vehicle-to-Grid in Deutschland," 2012.
- [27] W. Kempton and J. Tomić, "Vehicle-to-grid power fundamentals: Calculating capacity and net revenue," *J. Power Sources*, vol. 144, no. 1, 2005, doi: 10.1016/j.jpowsour.2004.12.025.
- [28] A. Kumar and S. R. Samadder, "A review on technological options of waste to energy for effective management of municipal solid waste," *Waste Management*, vol. 69, 2017, doi: 10.1016/j.wasman.2017.08.046.
- [29] M. A. Rajaeifar, H. Ghanavati, B. B. Dashti, R. Heijungs, M. Aghbashlo, and M. Tabatabaei, "Electricity generation and GHG emission reduction potentials through different municipal solid waste management technologies: A comparative review," *Renewable and Sustainable Energy Reviews*, vol. 79, 2017, doi: 10.1016/j.rser.2017.04.109.

- [30] B. Baran, M. S. Mamis, and B. B. Alagoz, "Utilization of energy from waste potential in Turkey as distributed secondary renewable energy source," *Renew. Energy*, vol. 90, 2016, doi: 10.1016/j.renene.2015.12.070.
- [31] B. Baran, M. S. Mamis, and B. B. Alagoz, "Utilization of energy from waste plants for microgrids," 2016, doi: 10.1109/SGCF.2016.7492431.
- [32] P. Ghaebi Panah, R. A. Hooshmand, M. Gholipour, and M. Bornapour, "Urban microgrid ancillary service provision using plugin electric vehicle and waste-to-energy CHP," *J. Energy Storage*, vol. 29, p. 101413, Jun. 2020, doi: 10.1016/j.est.2020.101413.
- [33] T. U. Berlin and B. Stadtreinigungsbetriebe, "Gesamtkonzept für die Elektrifizierung von öffentlichem Bus- und Entsorgungsverkehr." 2015.
- [34] S. Gräbener, "Methodische Entwicklung und Bewertung von Elektrifizierungskonzepten für innerstädtische Nutzfahrzeuge." Berlin, 2017.
- [35] K. Nagel, R. Ewert, J. Bischoff, M. Maciejewski, and A. Grahle, "Dekarbonisierung des urbanen Verkehrs," 2020. [https://svn.vsp.tu-berlin.de/repos/public-svn/publications/vspwp/2020/20-05/Dekarbonisierung\\_des\\_urbanen\\_Verkehrs-2020-02-26.pdf](https://svn.vsp.tu-berlin.de/repos/public-svn/publications/vspwp/2020/20-05/Dekarbonisierung_des_urbanen_Verkehrs-2020-02-26.pdf).
- [36] O. Erdinç, K. Yetilmezsoy, A. K. Erenoğlu, and O. Erdinç, "Route optimization of an electric garbage truck fleet for sustainable environmental and energy management," *Journal of Cleaner Production*, vol. 234, pp. 1275–1286.
- [37] S. Faddel, A. T. Al-Awami, and O. A. Mohammed, "Charge control and operation of electric vehicles in power grids: A review," *Energies*, vol. 11, no. 4. 2018, doi: 10.3390/en11040701.
- [38] D. Sauer, "Untersuchungen zum Einsatz und Entwicklung von Simulationsmodellen für die Auslegung von Photovoltaik-Systemen -Diplomarbeit," 1994.
- [39] M. Kwon, S. Jung, and S. Choi, "A high efficiency bi-directional EV charger with seamless mode transfer for V2G and V2H application," 2015, doi: 10.1109/ECCE.2015.7310418.
- [40] M. Simpson, "SPIDERS Bi-Directional Charging Station Interconnection Testing," United States, 2013. doi: 10.2172/1096678.
- [41] R. B. Carlson, D. Scofield, and B. Bennett, "Results from the Operational Testing of the General Electric Smart Grid Capable Electric Vehicle Supply Equipment (EVSE)," no. December.
- [42] B. Zakeri, S. Syri, and F. Wagner, "Economics of energy storage in the German electricity and reserve markets," 2017, doi: 10.1109/EEM.2017.7981914.
- [43] M. Loesch, J. Rominger, S. Nainappagari, and H. Schmeck, "Optimizing bidding strategies for the German secondary control reserve market: The impact of energy prices," 2018, doi: 10.1109/EEM.2018.8469993.
- [44] F. Eriksen, "Germany introduces competitive system for balancing fluctuations in the electricity grid," *Clean Energy Wire*, 2019. <https://www.cleanenergywire.org/news/germany-introduces-competitive-system-balancing-fluctuations-electricity-grid> (accessed Aug. 21, 2020).